



Distributed by



ALWAYS
THE BEST
**FLEXIBLE
SAFETY
BARRIERS**





DOES YOUR ORGANISATION HAVE THE NECESSARY **PROTECTIONS AGAINST DAMAGE TO PROPERTY AND PERSONAL INJURY?**



REQUEST A CHECK-UP FOR YOUR COMPANY!

Did you know that...

70%

of **accidents in the workplace affecting property and people** are due to the absence of impact protections.

50%

of **company maintenance costs each year** are caused by the repair and replacement of machinery and infrastructure due to damage caused by accidental impact.

80%

is the potential **saving** available by installing **protections made of polymers** rather than metal.



INVEST IN **SAFETY**

MPM designs and manufactures industrial protections to create safe conditions in the workplace in the presence of moving vehicles, goods, and people.

MPM protections make it possible to **avoid accidents** and damage, **safeguarding pedestrians and workers**. Ideal for **protecting racks, structures, vehicles, and machinery**, MPM protections allow your company to make **savings** in terms of the cost and time required for maintenance, repairs, and replacements, achieving the **maximum return on investment**.

A **safe workplace** improves the **quality of work**, with positive effects on your **corporate performance** parameters while enhancing the **perception of value** of the organisation.



TECHNOPOLYMER PROTECTIONS

FROM DRAWING BOARD TO PRODUCTION.
A PRODUCT THAT INCORPORATES ALL OUR KNOW-HOW.

MPM is the global answer for all organisations seeking **innovative and high-quality** solutions in the sphere of **safety**.

Our materials are composed of a unique blend, developed in our in-house laboratory by our experts and technicians.

Ingenuity and the Italian spirit of innovation have been deployed in full to meet the safety needs of a constantly evolving market.

PRACTICAL AND MODULAR DESIGN

Rugged arch section structure and large side impact surface, designed to minimise penetration by forks and pallets.

COMPACT DESIGN

Reduced functional footprint

IMPACT RESISTANCE

TUV SUD certified performance that is dependable through time

High Density
TECHNOPOLYMERS

FLEXIBILITY AND SHAPE-MEMORY

High kinetic energy absorption, limiting shock loads transmitted to vehicle operators, damage to vehicles, and damage to flooring

EASY INSTALLATION
and assembly

PRODUCTION

More than 40 years' experience in the production of plastic materials make **MPM the optimal partner** in the safety sector, offering customised solutions that meet the very highest quality standards.

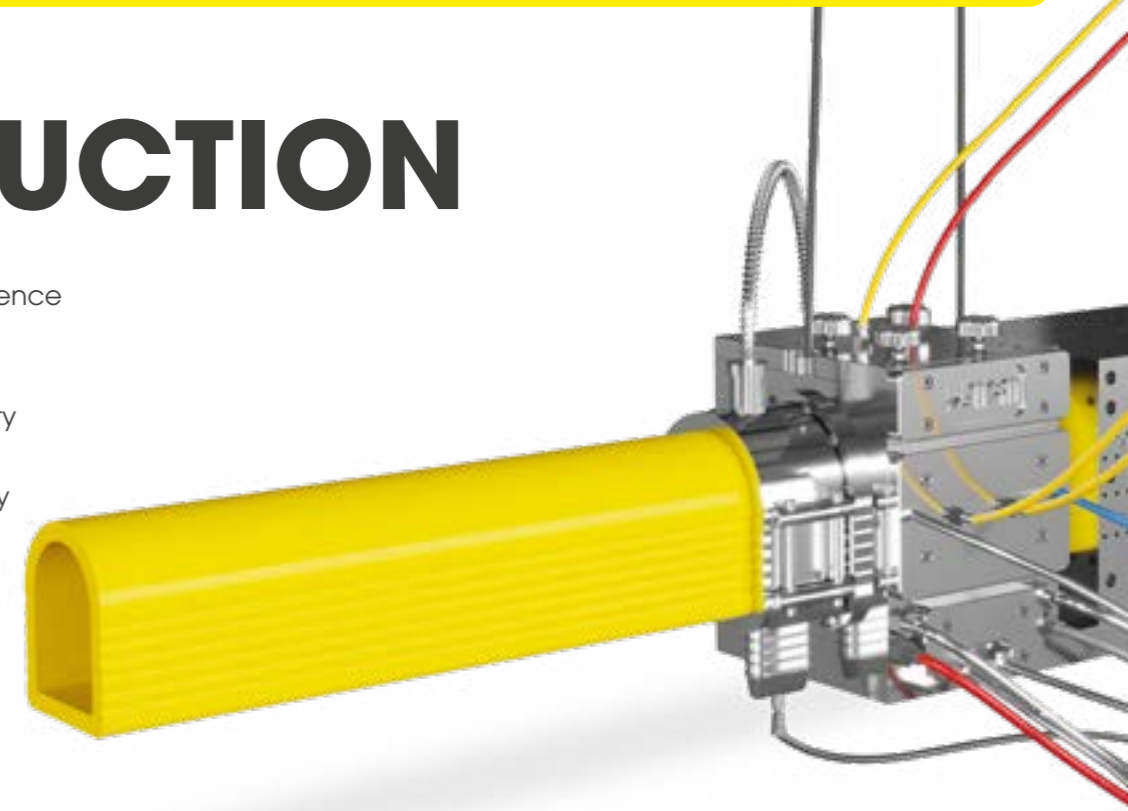

THE FIGURES

25,000

m² manufacturing space.

5 Million

kg extruded profiles each year.

H24

round-the-clock production.

ALL THE BENEFITS OF MPM TECHNOPOLYMERS

REFLEX
RESISTANT AND FLEXIBLE

FROSTEX
RESISTANT TO LOW TEMPERATURES



DURABILITY THROUGH TIME

100 years



HIGH FLEXIBILITY



RoHS compliant

COMPLIANCE WITH EU DIRECTIVE 2015/863 (ROHS)



100% RECYCLABLE



SELF-EXTINGUISHING

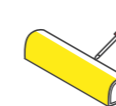

SCRATCH-RESISTANT MATERIAL



COLOURED MATERIAL. NO REPAINTING REQUIRED



EASY TO WASH



MOULD RESISTANT



NON-TOXIC

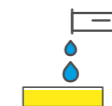

RESISTANT TO CHEMICALS



IPX9K WATER INGRESS PROTECTION



RESISTANT TO HUMIDITY AND SALINE SUBSTANCES

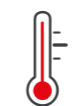

TEMPERATURE RANGE: - 30° + 60°



APPLICATION IN THE FOOD INDUSTRY

*Check the material technical datasheet for each product

WHY POLYMER PROTECTIONS MAKE SENSE

POLYMER VS METAL

POLYMER

MPM barriers guarantee enduring properties of strength and flexibility.

- ▶ The protection **flexes to absorb impact** and then returns to its original shape;
- ▶ The kinetic energy is not transmitted to the operator or the vehicle. This **prevents injuries and damage**;
- ▶ **Protection of flooring**;
- ▶ **High visibility** through time, with no need for repainting.

METAL

Metal protections are rigid and transmit impact energy to the ground.

- ▶ **Deformation is permanent** and means the protection must be replaced;
- ▶ High **shock loads transmitted to the operator with damage to vehicles**;
- ▶ **Break-up of flooring**;
- ▶ **Rust formation** and need for repainting.

Watch the video ▶



BEFORE



AFTER



BEFORE



AFTER



CERTIFIED QUALITY

Our products are **approved by reliable external certification agencies** of international renown. We believe in shared experience, ideas, and values. **We work with experts and technicians to define world industry standards.**



MORE THAN 200 TESTS PER MONTH

We guarantee **safe barriers and solutions for our customers all over the world**, subjecting our products to stringent impact tests to obtain reliable resistance data.

We have a large test bay where we conduct our testing and checking activities on a daily basis.



SOLUTIONS FOR INDUSTRIAL DOORS

BOLLARDS

APPLICATION

Near industrial doors, overhead doors, cold storage doors, loading bays, fire doors, blind spots, no-zones and projecting structures

SAFETY

- Intact and functional doors
- Undamaged door frames
- Reduction of accidents and collisions in critical transit points

SAVING

- Zero maintenance costs
- No cost for replacing damaged doors or repairing infrastructure

Innovative design with octagonal section



Rugged protective bollard for heavy loads

GRD 200

Category: BOLLARD

9,365 JOULES

Upgraded internal structure with **flexible shock absorbers** to dissipate kinetic energy

Heavy gauge plate with shock absorber. Easy to install



EXCLUSIVE INTERNAL DESIGN

Rugged outer cladding in scratch-resistant technopolymer

System of internal shock absorbers and airtight bumpers to withstand very high energy impacts

Steel core



◀ Watch the video

SOLUTIONS FOR RACK SYSTEM UPRIGHTS

RACK PROTECTOR

APPLICATION

For uprights of various shapes and sizes

SAFETY

- Maintains the structure and function of the upright even after repeated collisions
- Prevents dangerous collapse of racks and stored goods, avoiding the risk of material falling onto other structures or personnel

SAVING

- Lower costs for maintenance of uprights
- Reduced downtimes and no-go areas for repairs or maintenance

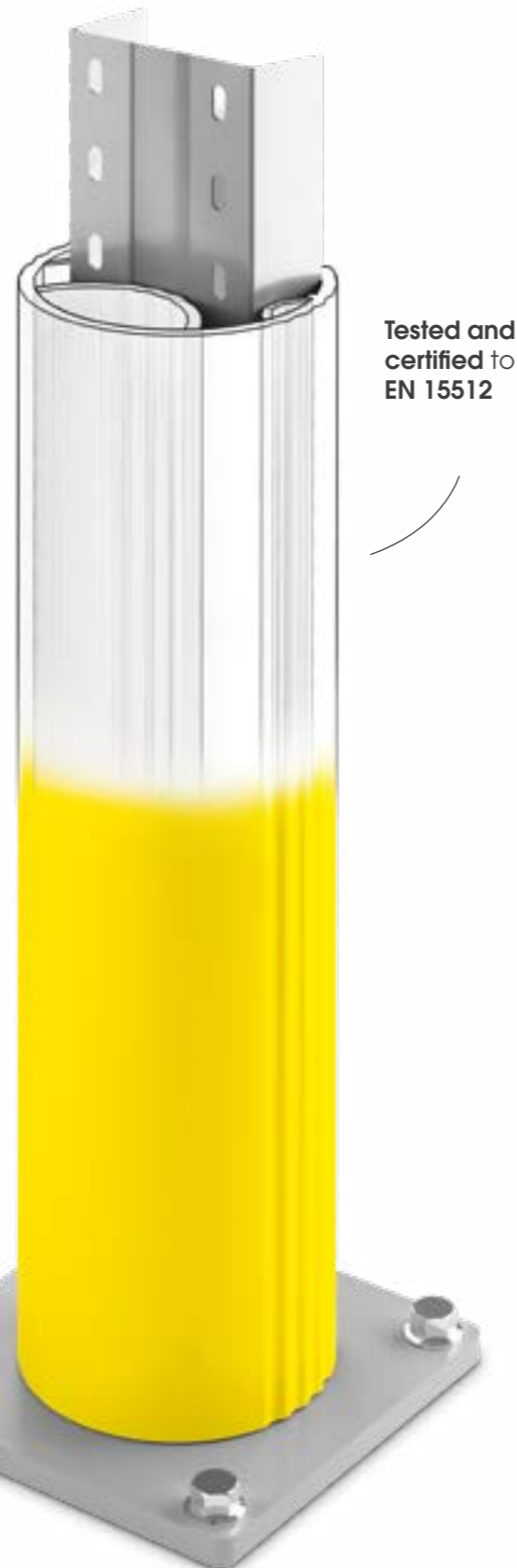

Tested and certified to EN 15512

RPM

Category: RACK PROTECTION

1,280 JOULES

Reduced dimensions to keep manoeuvring spaces clear

Interlocking system with practical click-fit tools

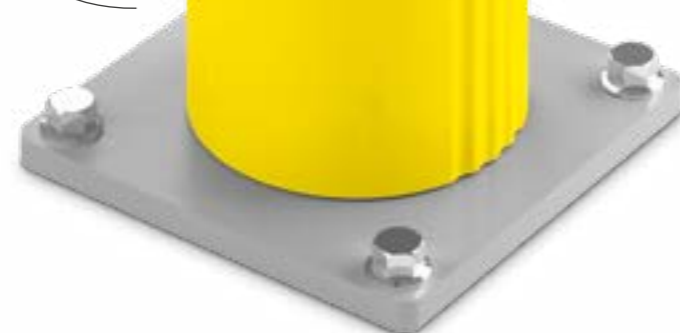

Two side shock absorbers in soft material to absorb impact during pallet placement on the rack

Central shock absorber in soft material to absorb front impacts

Interlocking system with practical click-fit tools. Quick and easy to install

Rigid outer cladding, scratch-resistant and easy to clean



◀ Watch the video



SOLUTIONS FOR RACK END BARRIERS

TRAFFIC BARRIERS

APPLICATION

In front of the ends of industrial racks to protect the most vulnerable points

SAFETY

- Racks remain intact
- Prevention of collapse and structural failure of racks
- Safeguarding of materials and operators

SAVING

- Reduction of costs for rack replacement
- Reduced downtimes and no-go areas for repairs or maintenance



Compact design
for unobstructed aisles

Quick and easy
assembly with a
single coupling rod.
Small number of
components

Easy installation
on floor

Tested and certified
to EN 15512

LM

Category: RACK PROTECTION

18,660 JOULES



◀ Watch the video

SOLUTIONS FOR PEDESTRIANS AND OPERATORS

PEDESTRIAN SAFETY BARRIERS

APPLICATION

To identify and delimit footpaths, crossings, and entrance and exit routes for operators, visitors, and pedestrians in general

SAFETY

- Safeguarding of operators and personnel who need to transit through logistic areas or assemble in safe zones of the warehouse
- Fewer accidents and injuries

RISPARMIO

- Avoid fines and lawsuits against persons in charge and proprietors in the case of accidents
- Avoid hikes in insurance premiums and social security costs

LINK 150/2

Category: LINK

40,858 JOULES

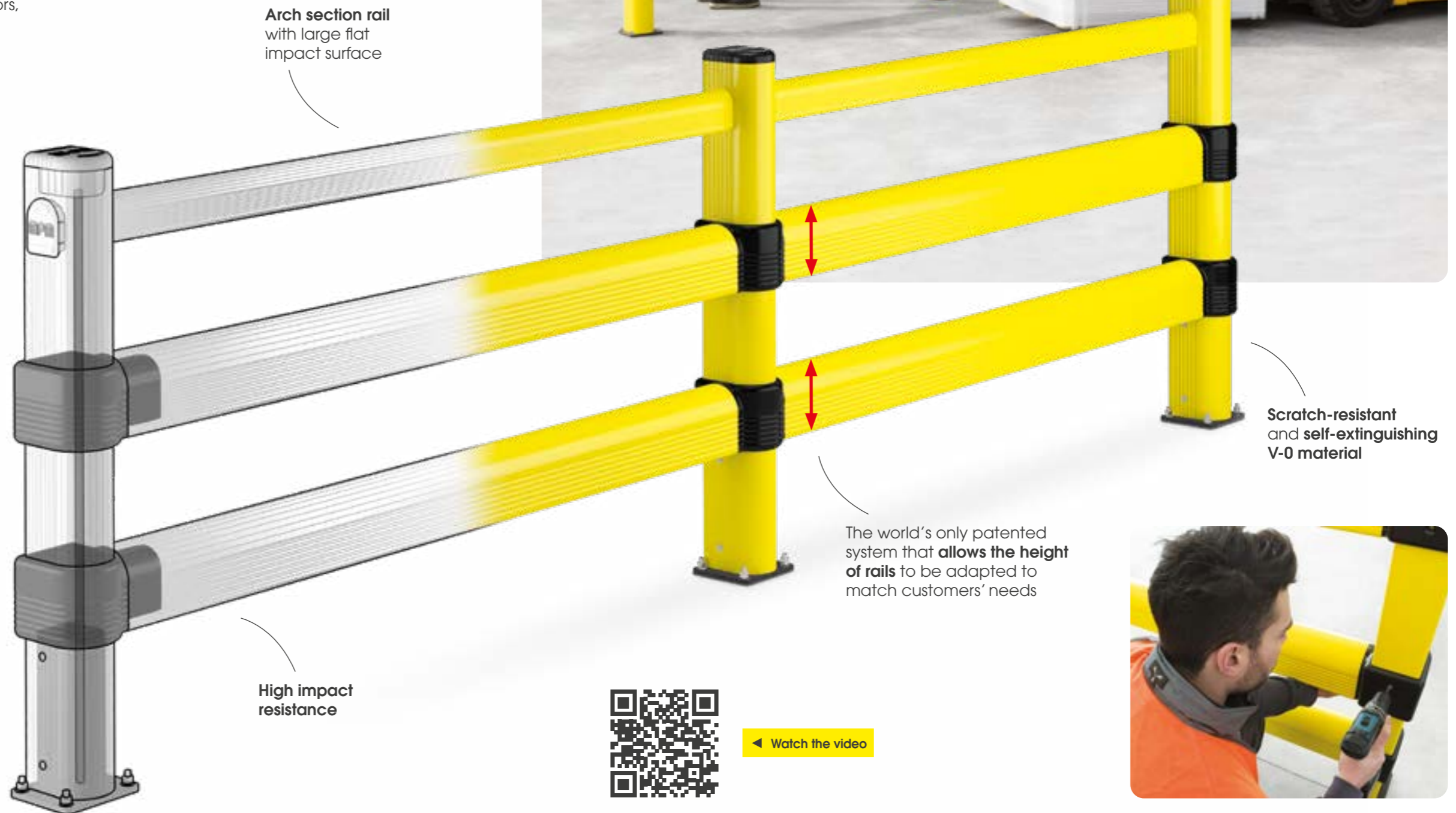

Arch section rail
with large flat
impact surface

High impact
resistance

Scratch-resistant
and self-extinguishing
V-0 material

The world's only patented
system that **allows the height
of rails** to be adapted to
match customers' needs



◀ Watch the video



SOLUTIONS FOR COLUMNS AND PILLARS

COLUMN PROTECTIONS

APPLICATION

On columns and pillars, also on just two or three sides

SAFETY

- Safeguard load-bearing columns and pillars to avoid structural damage to buildings
- Prevent physical trauma of vehicle operators due to shock loads resulting from impact against a column
- Provide a visual guide for forklift operators

SAVING

- Zero maintenance and damage to corners, projecting parts, and columns
- Prevent damage to vehicles

Modular design with customisable width and height

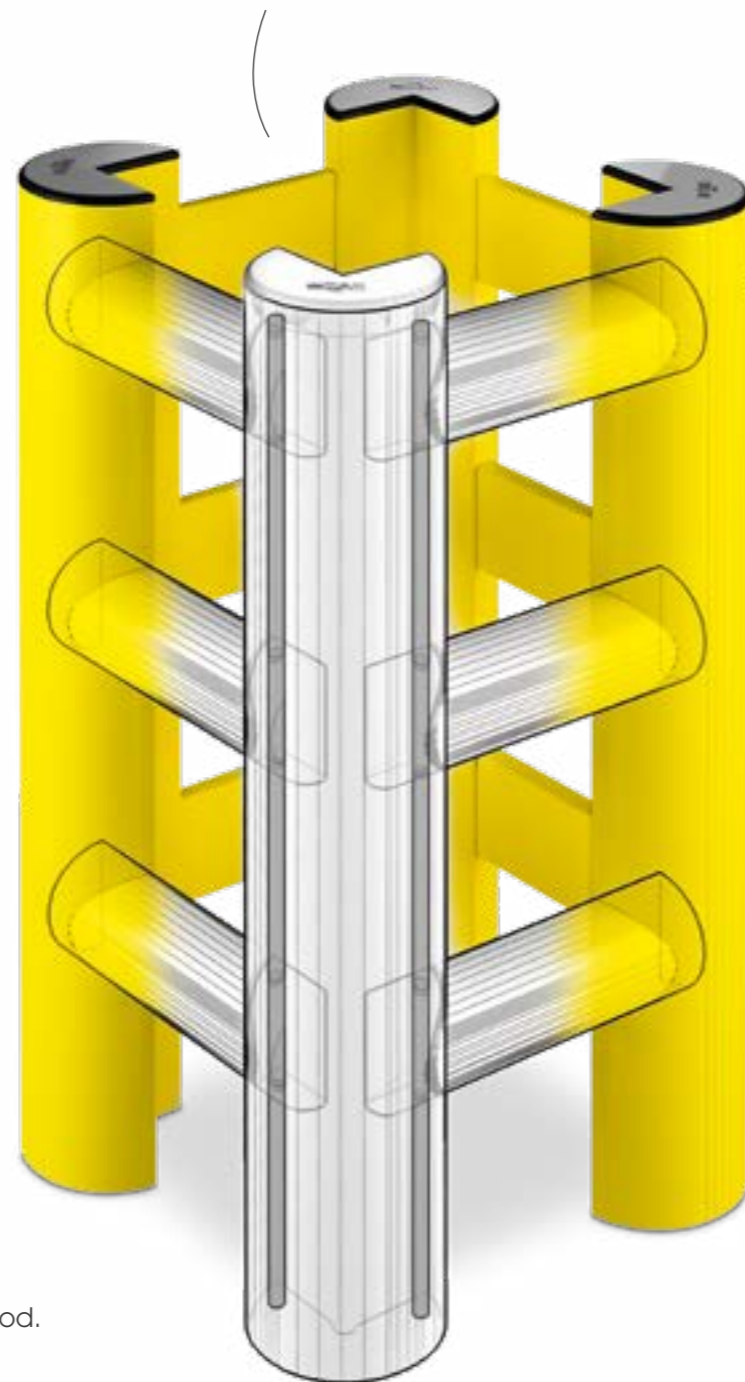

HUG TOWER

Category: COLUMN PROTECTION

HIGH FLEXIBILITY

Quick and easy assembly with a single coupling rod. Small number of components



For square or rectangular structures, on two or three sides

Free-standing structure with no fixings to either the column or the floor



◀ Watch the video



SOLUTIONS FOR WALLS AND MACHINERY

GUARD RAILS

APPLICATION

For installation near critical points of sandwich panels, masonry walls and drywalls, machinery, and conveyor belts

SAFETY

- Anti-fork solution designed to protect the base of vulnerable structures and valuable machinery
- Delimits traffic and defines routes for operator-driven vehicles and AGVs

SAVING

- Limits costs for maintenance or replacement of panels, walls, and machinery



GR 150

Category: **GUARD RAILS**

11,650 JOULES



◀ Watch the video

AN ALL-ROUND SERVICE

We believe that people and relationships are the true source of value in an organisation. Trust, respect, and sharing: our key strengths.

MPM was set up by a hard-working and visionary family who proceeded to build a solid company that is renowned at the national and international levels.



A TEAM
**ALWAYS AT
YOUR SIDE,
FOR A SAFE
AND
GUARANTEED
PRODUCT!**

To meet a range of diverse requirements, we send our experts out to inspect the areas to be protected so they can assess the risks and make a comprehensive analysis of specific needs.



We develop one-off and customised solutions. We supply a complete, quick, and precision service from drawing board to installation.

Our goal?
Complete satisfaction and safety
of our customers!
Place your project in the hands
of the MPM team!

* The resistance values in Joules shown in the catalogue refer to an impact at 45 or 90 degree angles. Contact the MPM team for further details.

A WORLDWIDE RESPONSE WITH DISTRIBUTION IN MORE THAN 70 COUNTRIES

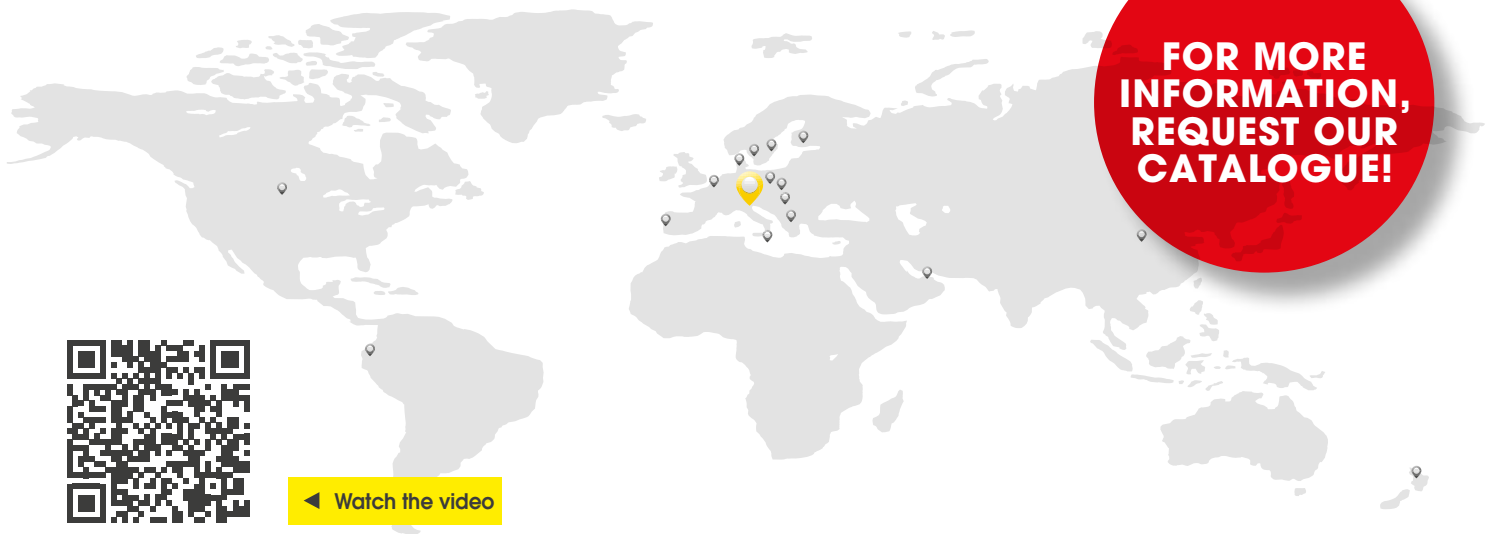

◀ Watch the video

THE WORLD'S TOP BRANDS CHOOSE OUR QUALITY MADE IN ITALY

MPM protective solutions are suitable for safety requirements in a **wide range of sectors.**

- TRANSPORT AND LOGISTICS
- RETAIL
- AUTOMOTIVE AND MECHANICAL
- ENGINEERING
- AIRPORTS
- FOOD & BEVERAGE
- CHEMICALS AND TEXTILES
- INDUSTRY AND PRODUCTION
- WAREHOUSE AND STORAGE



M.P.M. s.r.l.
Padua · Italy
T +39 049 9301773
info@mpmpvc.com
www.mpmprotections.com

Reseller



Profensa BV

+32 473 791 160 - Joris
+32 477 239 641 - Yves

info@profensa.be
www.profensa.be